



DVI-Ht (Model 8890)

GAS-FIRED DIRECT VENT FIREPLACE INSERT



We recommend that our gas hearth products be installed and serviced by professionals who are certified in the U.S. by the National Fireplace Institute® (NFI) as NFI Gas Specialists.



READ THIS OWNER'S MANUAL
Operate and maintain this gas heater according to instructions in this manual. Read this manual in its entirety

<p>FOR YOUR SAFETY: Do not store or use gasoline or other flammable vapors and liquids in the vicinity of this or any other appliance.</p>	<p>POUR VOTRE SÉCURITÉ: Ne pas entresposer ni utiliser d'essence ni d'autre vaperurs ou liquides inflammables dans le voisinage de cet appareil ou de tout autre appareil.</p>
<p>FOR YOUR SAFETY: What To Do If You Smell Gas:</p> <ul style="list-style-type: none"> • Do not touch electrical switches. • Do not try to light any appliance. • Do not use the phone in your building. • Immediately call your gas supplier from a neighbor's phone. • Follow your gas supplier's instructions. • If you cannot reach your gas supplier, call the fire department. 	<p>POUR VOTRE SÉCURITÉ: Que faire si vous sentez une odeur de gaz:</p> <p>Ne pas tenter d'allumer d'appareil. Ne touchez à aucun interrupteur. Ne pas vous servir des téléphones se trouvant dans le bâtiment où vous vous trouvez. Evacuez la pièce, le bâtiment ou la zone. Appelez immédiatement votre fournisseur de gaz depuis un voisin. Suivez les instructions du fournisseur.</p> <p>Si vous ne pouvez rejoindre le fournisseur de gaz, appelez le service dos incendies.</p>
<p>WARNING: Improper installation, adjustment, alteration, service or maintenance can cause injury or property damage. Refer to this manual. For assistance or additional information consult a qualified, service agency, or the gas supplier. In the Commonwealth of Massachusetts, all installation of gas lines and gas fitting shall only be done by a licensed gas fitter or licensed plumber.</p>	<p>AVERTISSEMENT: Une installation, un réglage, une modification, un entretien ou une maintenance incorrects peuvent entraîner des dommages matériels, des lésions corporelles ou la perte de vies humaines. Consulter le manuel des usagers fourn avec ce générateur d'air chaud.</p>

Intentionally Blank

TABLE OF CONTENTS

INTRODUCTION	5
CODES	5
SAFETY INFORMATION	6
SPECIFICATIONS	8
UNPACKING	9
CLEARANCES TO COMBUSTIBLES	10
VENTING COMPONENTS & CONFIGURATION	12
Restrictor Disc.....	12
Venting System Installation.....	13
ELECTRICAL CONNECTIONS	14
Wiring Instructions.....	14
GAS SUPPLY AND CONNECTIONS	16
ASSEMBLING AND INSTALLING THE UNIT	18
Log Placement within the Unit.....	18
Log Set Removal.....	18
Surround and Façade Installation.....	18
Installing the Unit.....	18
LIGHTING THE UNIT FOR THE FIRST TIME	20
Smoke and Fumes Warning.....	20
Odors and Impurities.....	20
Pilot Light Warning.....	20
Prepare for Lighting.....	20
Initial Adjustments.....	20
Lighting Instructions.....	20
Turning Off the Unit.....	21
PILOT AND BURNER FLAMES	22
MAINTENANCE AND CARE	23
Cleaning.....	23
Cleaning the Glass.....	23
PARTS LIST	24
TROUBLESHOOTING	26
SAFETY LABEL	29

INTRODUCTION

Congratulations on the purchase of your Hearthstone Gas-Fired Direct Vent Insert. The DVI-Ht incorporates the latest in energy and gas technology, which will provide you with clean, efficient heat for years to come. The combination of elegant cast iron and durable steel construction gives the DVI-Ht attractive looks and allows for years of durable performance, which can be maintained with minimal care.

If there are any questions regarding installation or operation, which are not answered within this manual, contact your local dealer or your building inspector.

Your DVI -Ht is equipped with a standing pilot which:

1. Generates a millivolt signal that powers the control circuit and;
2. Ignites the main burner when the switch or thermostat calls for heat.

This unit is equipped with a variable output control located on the gas control valve. The DVI-Ht also has a built in gas shut-off systems directly out of the valve. It allows you to vary the heat output, along with the flame height, to suit personal taste. Heat output can be reduced during the Fall and Spring (when the need for heat is reduced) and increased during Winter months (when the need for heat is the

greatest). Regardless of how you set the variable output control, the on/off cycling of the unit is always controlled by the on/off switch or the optional wall-mounted thermostat. Also available through your local Hearthstone dealer is an optional front door screen (Kit #98-69700) which enhances the realistic flame.

The unit is also equipped with a variable speed fan which turns on automatically and off independently of the burner flames. The fan turns on when the stove is hot and cycles off when the unit cools down. This ensures the blower moves warm air only.

The DVI-Ht will provide you with years of economical and convenient service. However, as with any gas appliance, the unit must be properly installed and maintained by a qualified service technician to ensure safe and trouble-free operation.

READ THIS OWNER'S MANUAL

Operate and maintain this gas heater according to instructions in this manual. Please read this manual in its entirety, before attempting to light the unit.

CODES

Adhere to all **local codes** or, in their absence, the latest edition of THE NATIONAL FUEL GAS CODE ANSI Z223.1 (NFPA54) which can be obtained from:
**AMERICAN NATIONAL STANDARDS INSTITUTE,
INC.**

1430 BROADWAY
NEW YORK, NY 10018
OR

**NATIONAL FIRE PROTECTION ASSOCIATION,
INC.**

BATTERY MARCH PARK
QUINCY, MA 02269

The appliance when installed must be electrically connected and grounded in accordance with local codes or, in the absence of local codes, with the current NFPA 70-National Electrical Code or CSA C22.1-Canadian Electric Code.

For mobile home installation, install per the Manufactured Home Construction and Safety Standard, Title 24 CFR, Part 3280 (U.S.) Or CAN/SCA Z240 MH (Canada). *(Installer l'appareil selon les codes ou règlements locaux, ou, en l'absence de tels règlements, selon les Codes d'installation CAN/CGA-B149.)*

SAFETY INFORMATION

Your DVI-Ht will remain appealing while providing years of quality performance when you follow a few simple safety precautions, and by performing minimal maintenance.

WARNING

ENSURE INSTALLATION AND REPAIR IS CONDUCTED BY A QUALIFIED SERVICE TECHNICIAN. HAVE A QUALIFIED SERVICE TECHNICIAN INSPECT THE APPLIANCE BEFORE USE AND AT LEAST ANNUALLY. CLEAN MORE FREQUENTLY IF NECESSARY DUE TO EXCESSIVE LINT FROM CARPETING, BEDDING MATERIAL, ETC. IT IS IMPERATIVE THAT CONTROL COMPARTMENTS, BURNERS, AND CIRCULATING AIR PASSAGES OF THE APPLIANCE ARE KEPT CLEAN AND FREE OF OBSTRUCTIONS. (S'ASSURER QUE LE BRÛLEUR ET LE COMPARTIMENT DES COMMANDES SONT PROPRES. VOIR LES INSTRUCTIONS D'INSTALLATION ET D'UTILISATION QUI ACCOMPAGNENT L'APPAREIL.

IMPORTANT

Please read and understand all warnings before installing or operating this heater. Failure to follow these instructions or improper use of this heater will void the warranty and can cause serious injury or death from burns, fire, explosion and carbon monoxide poisoning. Do not attempt to alter or modify the construction of this heater or its components. Any alteration or modification of construction voids the warranty and the certification of this heater. Save this manual for future reference.

FIRE HAZARD

Do not store or use gasoline or other flammable vapors or liquids in the vicinity of this appliance. Locate the DVI-Ht out of traffic and away from furniture, draperies, clothing, and flammable material.

NEVER BURN PAPER, WOOD, OR OTHER MATERIALS

This gas heater is designed to burn either natural gas (NG) or liquid propane (LP). Never burn any fuel which was not intended for use in this unit.

The installation must conform with local codes or, in the absence of local codes, the current National Fuel Gas Code, ANSI Z223.1 (NFPA 54).

Do not use this appliance if any part was under water. Immediately call a qualified service technician to inspect the heater and to replace any part of the control system and gas control, which was under water. *(Ne pas se servir de cet appareil*

s'il a été plongé dans l'eau, complètement ou en partie. Appeler un technicien qualifié pour inspecter l'appareil et remplacer toute partie du système de contrôle et toute commande qui ont été plongés dans l'eau.)

During the first few hours of operation the appliance may produce a slight smoke and/or odor. This is normal during the first several burns. During the initial burn, open a window(s) to assist in the removal of the smoke/odor. If the logs appear to smoke, turn the heater off and call a qualified service technician.

Disconnect the appliance and its individual shutoff valve from the gas supply piping system during any pressure testing of that system at test pressures in excess of 1/2 psig. (3.5k Pa). The appliance must be isolated from the gas supply piping system by closing its individual manual shutoff valve during any pressure testing of the gas supply piping system at test pressures equal to or less than 1/2 psig (3.5 kPa).

TEK LOG SAFETY INFORMATION

If the decorative TEK log material supplied with the DVI-Ht is damaged or missing, it must be replaced with the same, approved replacement parts supplied by the manufacturer. These components affect the combustion quality and safety of the heater. Do not replace fiber TEK logs with unapproved TEK logs or any other material. **Always wear gloves and safety goggles while handling the ember bed and log set**

SHOCK HAZARD

This appliance is equipped with a three-prong (grounding) plug for protection against shock hazard. Use only in a properly grounded three-prong receptacle. Do not cut or remove the grounding prong from the plug.

WARNING

DO NOT CONNECT THIS GAS APPLIANCE TO A CHIMNEY FLUE SERVING A SEPARATE SOLID-FUEL BURNING APPLIANCE.

SERVICE CAUTION

If you believe your DVI-Ht is not, in any way, performing properly, immediately discontinue operation until the unit is inspected and approved by qualified service personnel. Prior to servicing the unit, turn the valve control knob clockwise to "OFF". Ensure the unit is cool prior to servicing and

cleaning. Replace any component removed during servicing prior to operation. Use of any components not supplied by Hearthstone on the stove voids all warranties. **Do not substitute components.**

DO NOT LIGHT PILOT OR MAIN BURNERS BY HAND

The standing pilot light equipped with this gas heater is lit by using a battery operated spark generator, as described in the *How To Turn the Unit On & Off* section of this manual. Never attempt to light the pilot or main burners by hand (with a match or lighter). After repeated attempts, if the pilot light fails to light, discontinue operation; turn off the gas at the gas control valve, and immediately contact qualified service personnel for assistance.

HOT SURFACES

Certain exposed surfaces of the DVI-Ht will reach high temperatures during normal operation. Maintain clearances to combustibles as specified in the *Clearances To Combustibles* section of this

manual. Due to high temperatures the appliance locate it out of traffic and away from furniture, draperies, clothing and flammable materials. Alert children and adults to the hazards of high surface temperatures, and to the need to stay away to avoid burns to skin or clothing ignition. Supervise young children carefully when they are in the same room as the appliance. Do not place clothing or other flammable material on or near the appliance. (Surveillance les enfants. Garder les vêtements, les meubles, l'essence ou autres liquides à vapeur inflammables lin de l'appareil.) Clean the area around the unit on a regular basis to prevent the accumulation of dust and lint.

ALWAYS VENT TO THE OUTSIDE

Never vent the gas heater to other rooms or buildings. Do not burn the gas heater with the front open. Do not burn gas heater with broken glass. Only open front for routine service. Do not slam or strike glass.

SPECIFICATIONS

Listed:

Direct Vent Gas Fireplace

Model:

DVI-Ht Room Heater

Testing Agency:

Intertek Testing Services NA Inc. (ITS)

Tested to:

ANSI Z21.88-05 and CSA 2.33-05

This installation must conform with local codes or, in the absence of local codes, the current National Fuel Gas Code-ANSI Z223.1 (NFPA 54) or CAN/CGA B149 Installation Code.

Installer l'appareil selon les codes ou règlements locaux, ou, en l'absence de tels règlements, selon les Codes d'installation CAN/CGA-B149

Certified for use by:

Board of State Examiners of Plumbers and Gasfitters
100 Cambridge Street, Room 1511

Boston, Massachusetts 02202

CAUTION: REPLACE ANY SCREENS OR SAFETY GUARDS REMOVED FOR SERVICE WORK PRIOR TO OPERATING THIS APPLIANCE!

Specification

Specification	Natural Gas	LP
Input rating (Btu/hr)	33,000	33,000
Maximum output (BTU/hr)	26,900	26,200
Minimum input rating (Btu/hr)	13,000	12,000
Orifice size DMS	43,52	55,62
Man. pressure-HI setting (in. w.c./kPa)	3.5/1.15	10.0/0.8
Man. Pressure-Lo setting (in.w.c./kPa)	1.2/0.3	3.3/1.59
Inlet pressure-MAX (in. W.c./kPa)	10.5/2.6	14.0/3.47
Inlet pressure-MIN (in. W.c./kPa)	5.0/1.24	11.0/2.88

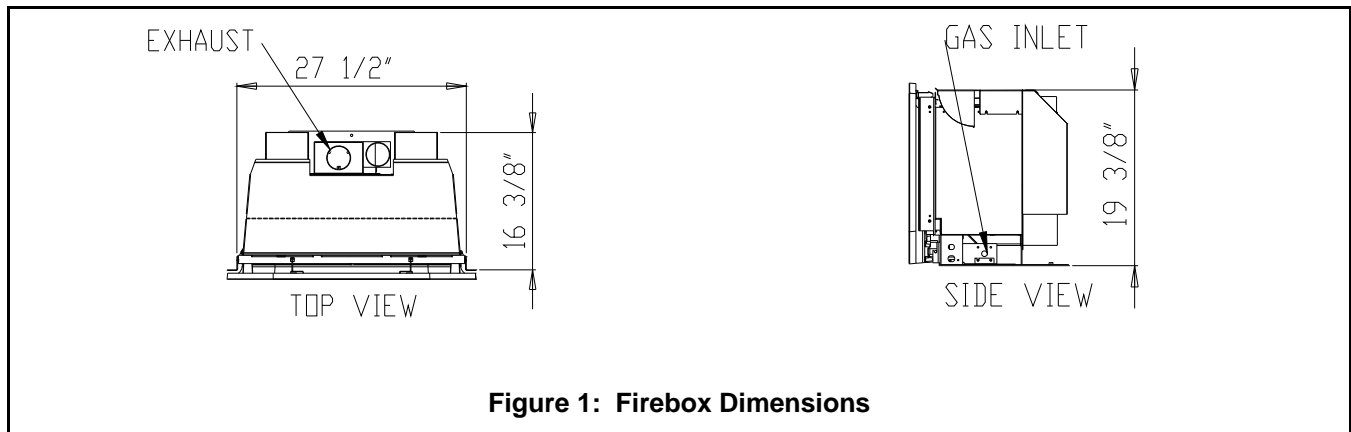

Conditionally approved for purchased mobile home installation. This appliance may be installed in an aftermarket permanently located, manufactured (mobile) home, where not prohibited by local codes.

This appliance is only for use with the type of gas indicated on the rating plate. This appliance is not convertible for use with other gases, unless a qualified Hearthstone kit is used.

Cet appareil peut être installé dans un after market situé définitivement, fabriqué (mobile) logement, où ne prohibé pas par des codes ocaux.

Cet appareil est seulement pour l'emploi avec le type de gaz indiqué sur l'assiette d'évaluation. Cet appareil n'est pas décapotable pour l'emploi avec autres gaz, à moins qu'un équipement certifié est employé.

UNPACKING

Inspect for Damage

The DVI-Ht is packaged by the manufacturer to withstand shipment without damage under most circumstances. However, damage can occur during transit and handling. Care should be taken when unpacking, inspecting for damage, and installing the unit. **If any damaged or missing parts are detected, immediately contact your dealer.**





A complete DVI-Ht is shipped with three packages. Locate and remove these packages. Package #1 will contain the Log Set. Package #2 will contain the front set, doors, and grills. Package #3 will contain the optional surround if ordered. Lift the stove off the pallet and partially insert it into the fireplace, (with regards to the *Clearances To Combustibles* section on page 10 of this manual). Carefully remove the surround set and front set from the packaging carton.





Inspect the DVI-Ht for visible and/or concealed damage. The unit should appear to be square and true. The sheet metal parts should be smooth and free of bends and/or dents. If the facade is enameled, the enameled cast iron should be free of chips and/or cracks. If visible or concealed damage is found or suspected, contact your local dealer for instructions. To open the firebox, reach over the firebox, and under the front grill. With a flat screwdriver turn the retaining clips up. There will be four separate clips. Be careful, when you lift the last one, as it will free the glass and frame from the unit. Pull the top of the glass towards your body, and lift the glass and frame up and away from the unit. Carefully set the glass and frame away from the unit, as it will need to be installed later. Inspect the log set for damage. It is important to wear safety goggles and gloves when handling the log set. If a damaged log is encountered, contact your local dealer for a replacement log. Put the log set, aside. It will be installed later.

Install "AA" battery in the pilot igniter box under the gas component tray before trying to light the unit.

Components

1-DVI -Ht (with accessory box)

-  4 Decorative logs
-  1 Pilot shield
-  1 Bag of Embers
-  1 Bag of Platinum Bright Embers

-  40' Wire
-  1 Thermostat
-  1 LP Conversion Kit
-  1 Restrictor Disc
-  2 Metal Surround Flanges

Façade Assembly























- See packing list.

Surround Assembly

- See packing list

 **WARNING: DO NOT STRIKE, HIT OR SLAM THE GLASS SHUT IN ANY WAY. IT MAY CAUSE INJURY OR DISTURB THE PERFORMANCE OF THE APPLIANCE**

Items Required for Complete Installation of the Unit

-  Surround Set
-  Two - 3" Flex Liners (Dura-Vent #2280)
-  Co-Linear Chimney Liner Termination Kit (Dura-Vent #923GK)
-  High Wind Termination Cap (Dura-Vent #991)
-  Four - 3.5" Hose Clamps
-  Gas Hookup Equipment/Tools
-  High Temperature Silicone
-  Small Level
-  Phillips Screwdriver
-  Slotted Screwdriver or 5/16" Nut Driver
-  Thread Sealant
-  Open End Wrenches or Adjustable Wrench
-  Permanent Marker
-  Fiberglass insulation
-  Safety glasses
-  Gloves
-  An external regulator (for Propane/L.P. gas only)
-  Gas piping which complies with local codes
-  Pipe sealants approved for use with propane/L.P. Gas (resistant to sulfur compounds)
-  A sediment trap
-  Pipe wrenches
-  Other parts required by local code

CLEARANCES TO COMBUSTIBLES

Due to high surface temperatures, locate the unit away from furniture and draperies. Do not place clothing and other flammable material on or near the heater. Always maintain adequate clearances around the air openings in the façade and allow for adequate ventilation. Maintain minimum clearances to combustibles as shown in *Figure 2 and 3*.

Hearth Requirements

The DVI ht requires a non-combustible hearth pad that extends no less than 14" in front of the unit. It must also extend 27 1/2" wide, centered in front of the glass. **If the DVI ht is raised at least 4" off the floor, no hearth pad is required.**

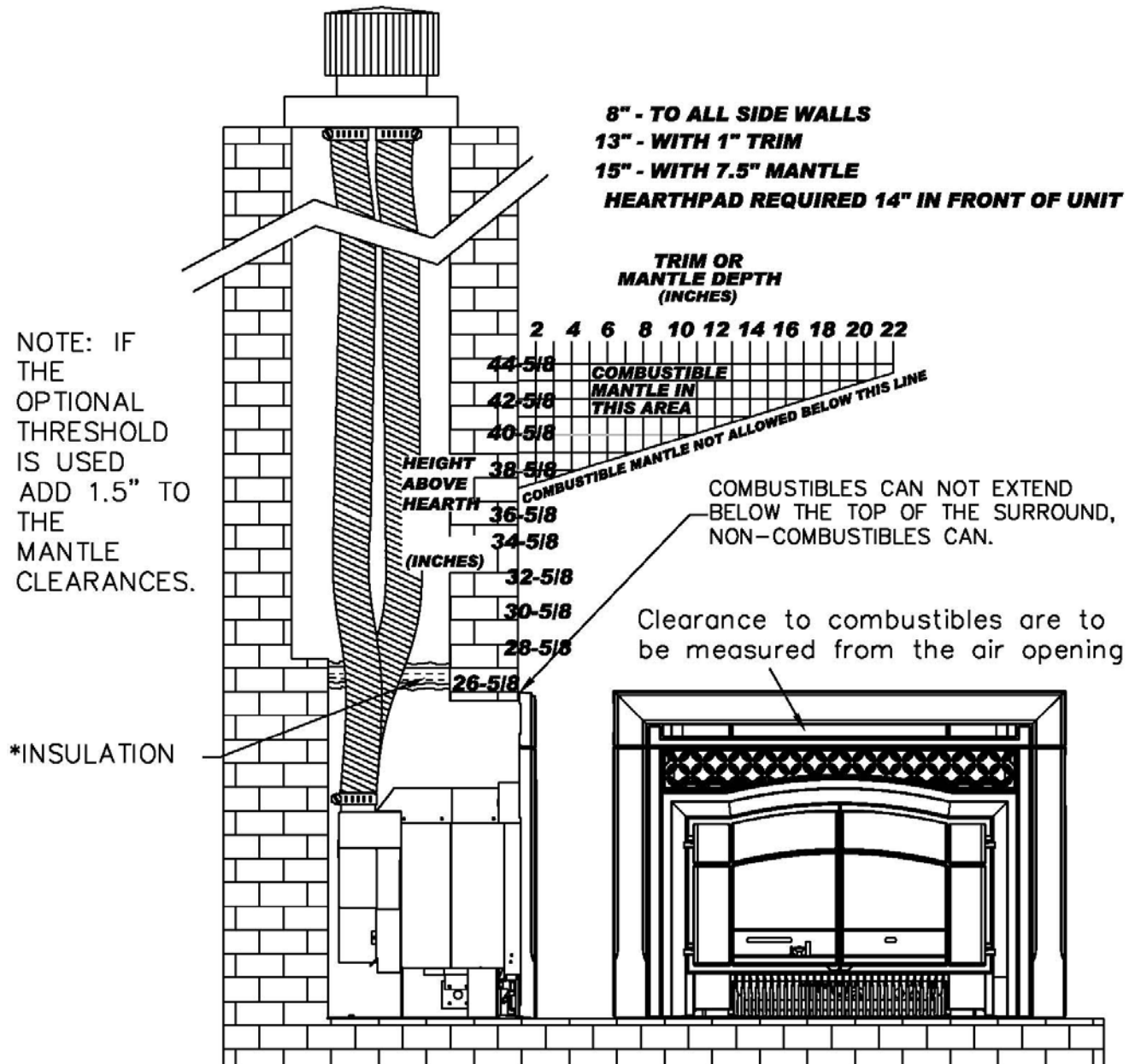

Figure 2: Clearance to Combustibles (*Insulation recommended)

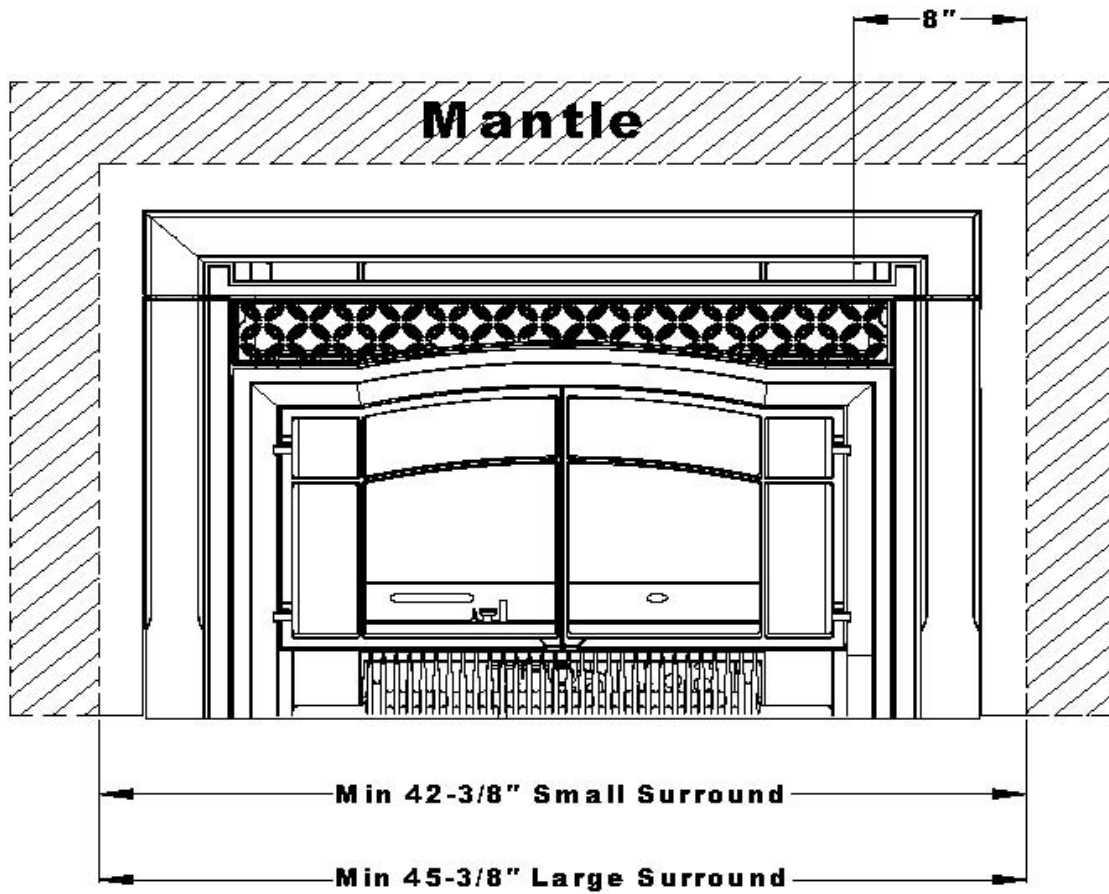

Figure 3: Surround Clearance to Combustibles

VENTING COMPONENTS & CONFIGURATION

DO NOT vent The DVI-Ht jointly with any other solid fuel or gas appliance. Vent the DVI-Ht directly to the outside of the building using a proper termination as listed in the following pages. Typical venting configurations are shown in *Figures 4 & 5*. If the vent-air system is disassembled for any reason, reinstall per the instructions provided in the *Assembling the Unit* section of this manual on page 18.

Restrictor Disc

Your DVI-Ht is supplied with a vent restrictor disc. This disc will provide excellent restriction for vertical vent runs exceeding 20 feet. If your vertical rise is less than 20 feet, use of the restrictor is not necessary. See *Figure 6*.

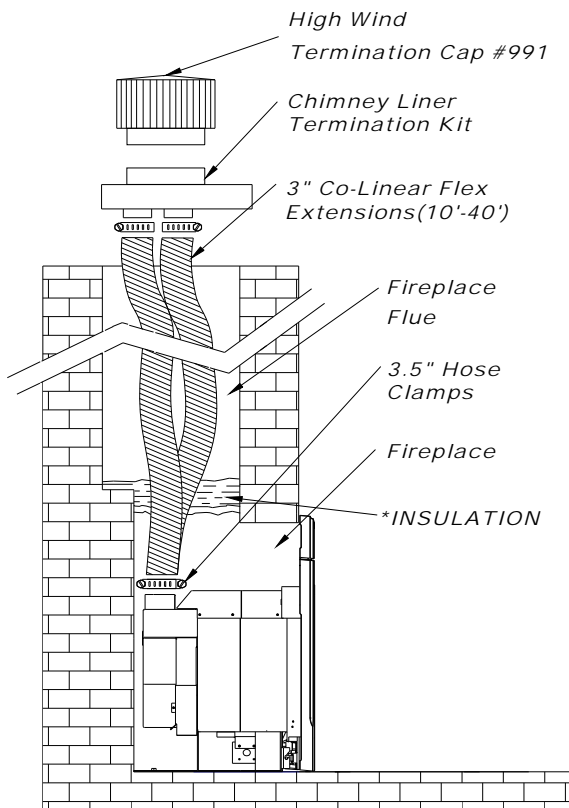

Figure 4: Co-linear Flex System

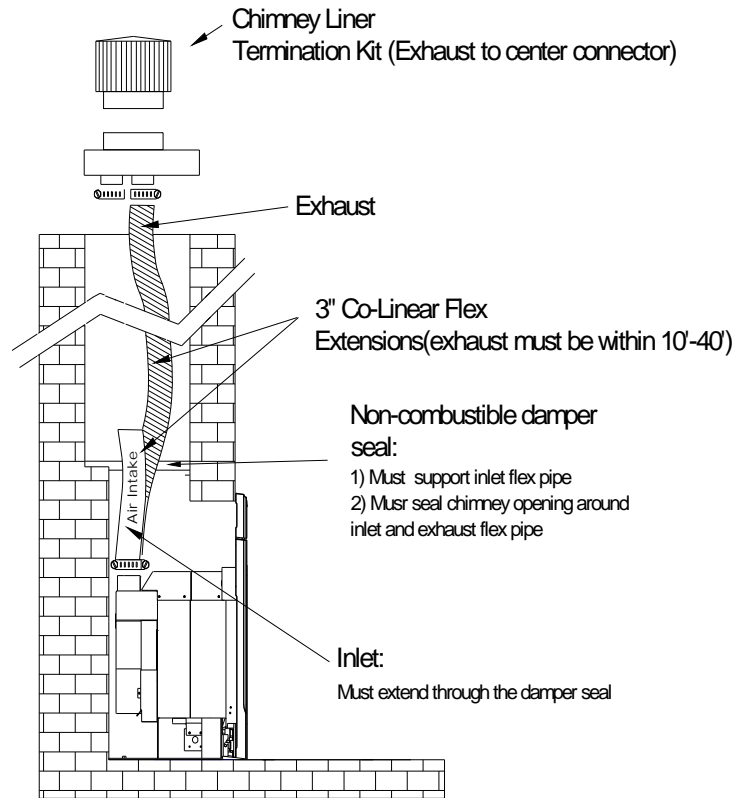

Figure 5: Chimney Air System

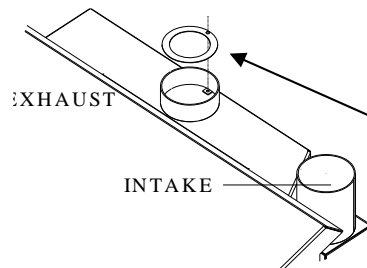

Figure 6: Restrictor Disc

Venting System Installation

1. Chimney Liner System*

1. Two Sections 3" Co-Linear Flex Liners (10ft Min./40 ft Max.). Dura-Vent #2280
2. Chimney Liner Termination Kit (Includes Co-Linear to Co-Axial Termination and Flashing) Dura-Vent #923GK
3. High Wind Termination Cap Dura-Vent #991
4. High Temperature Silicone
5. Four 3-1/2" Hose Clamps (all steel or stainless)
6. *Available through your local Hearthstone dealer.

 **WARNING! UNDER NO CIRCUMSTANCES BLOCK THE FLOW OF COMBUSTION OR VENTING AIR.**

Before You Begin

Ensure the masonry fireplace and flue complies with the applicable codes and both are in good condition. Repair any damage before installation of the DVI-Ht begins. Prepare a zero clearance (metal) fireplace by doing the following:

1. Install the label provided on the inside of the firebox.
2. Remove the damper, grate.
3. If necessary, remove the smoke shelf, internal baffles, screen, masonry lining and doors. (see the Dimensions in *Figure 1*).
4. **DO NOT** remove any insulation or structural frame members.
5. **DO NOT** remove or alter the metal sides, floor, door frame, or face of the fireplace.

The gas line enters the valve on the right side of the unit with a provided 24" flexible connector.



Installation of the Co-linear Vent Pipe

Mark each end of one of the flexible vent pipes "intake" with a permanent marker. Mark each end of the other flexible vent pipe "exhaust".

- Apply the high temperature silicone on the upper portion of the vent (flex pipes to co-linear to co-axial adaptor). **Important:** Ensure the pipe connected to the exhaust on the stove connects to the exhaust portion of the co-linear to co-axial adaptor. Ensure you meet all the manufacture's requirements when installing the adaptor and cap assembly. Follow the manufactures instructions when installing the same. (The exhaust pipe on the co-linear to co-axial adaptor is the pipe that is in the center of the adaptor.)
- Repeat this process to the top outer edge of both the intake and exhaust collars on the back of the unit. The exhaust adaptor is the collar nearest

the center of the unit, the intake adaptor collar is on the right side of the stove (*refer to Figure 1, on page 7*) Install the restrictor if necessary. Slide a hose clamp over the ends of both flexible vent pipes. Place the flexible vent pipe marked "intake" onto the intake collar, place the flexible vent pipe marked "exhaust" onto the exhaust collar. Secure them to the collar adaptors by tightening the hose clamps with a slotted screwdriver or 5/16" nut driver.

Observe the following guidelines when installing the vent pipes:

-  **Do not** install the venting into a chimney serving another appliance, be it fossil fuel, solid fuel, or another gas.
-  **Do not** crimp or rupture the vent pipes.

2. Using the existing chimney as an air inlet

The following installation procedure is not covered under the ANSI Z21.88 test method and product certification. Use of an existing chimney as an air intake must be specifically approved by your gas supplier and the local code Authority Having Jurisdiction.

The chimney flue must be carefully sealed from the room environment. Fabricate a plate of non-combustible material and carefully fit it to the damper area with high temperature sealant (see figure 5).

 **NOTE:** Seal all joints. Avoid leakage around the damper seal.

 **WARNING: THIS INSTALLATION MAY NOT WORK IN A NEGATIVE PRESSURE ENVIRONMENT, OR IF A SEAL CANNOT BE ATTAINED. IF SOOTING, OR GHOSTING OF THE FLAMES OCCURS, PLEASE CHECK AND REPAIR LEAKAGE, OR CHIMNEY SYSTEM.**

This stove is certified for use with a coaxial venting system. ANSI Z21.88 standards state that the maximum leakage rate for the venting system is 32 SCFM @ .06" w.c. This leakage must be accounted for if you use the chimney for intake air.

 **CAUTION: A REVERSE FLUE CONDITION CAN OCCUR IF THE VENTING IS NOT ATTACHED CORRECTLY, OR IF THE UNIT IS LIT BEFORE THE GLASS FRONT IS SECURED. A REVERSE FLUE CONDITION CAN DAMAGE THE UNIT.**

ELECTRICAL CONNECTIONS

Install the “AA” battery in the pilot igniter box under the gas component tray before attempting to light the unit.

 **NOTE:** OPEN VALVE DOOR ON THE CENTER BOTTOM OF THE FRONT FOR ACCESS TO ELECTRICAL AND GAS CONNECTIONS

Electrical Grounding Instructions

This appliance is equipped with a three-prong (grounding) plug for your protection against shock hazard. Use only a properly grounded three-prong receptacle. Do not cut or remove the grounding prong from this plug. Place the receptacle to the right of, or behind the unit.

Switch Plate

The DVI-Ht comes pre-wired to the control switches. To install, use the two 10-24 x ½” screws to mount the plate to the left surround panel. The plate will fit in the recessed side of the surround.

Thermostat

The fireplace insert is operated by the on/off/thermostat switch. You can control the DVI-Ht automatically with the provided wall mounted thermostat. We recommend installation of the thermostat for a more comfortable, automatic performance; however you can still override the thermostat by setting the switch to “on”. The thermostat controls the unit by “calling for heat.” The thermostat turns the unit on when the room is cold, and turns the unit off once the room is warmed sufficiently. The thermostat is controlled by a 750 millivolt DC, two-wire circuit. The thermostat comes with 40' (12m) of thermostat wire.

Thermostat Wiring

The thermostat wire from the unit to the thermostat can be surface mounted, routed under the floor, or through walls, etc. Connect the thermostat to the unit using no more than the 40' (12 m) of insulated thermostat wire provided. Ensure you leave a small coil of wire behind the unit so that it can be moved out of position for servicing and cleaning.

Thermostat Placement

Place the thermostat in the same room or living space as the unit. Typically 5' (1.5 m) off the floor and away from any influences that may cause the temperature in the vicinity of the thermostat to be unrepresentative of the room temperature in general. Such influences might include strong lighting, a heater vent from the central heating system, or a nearby drafty window. Placement of the thermostat on an inside wall rather than an outside wall is preferable. Do not place the thermostat directly over, or too close to the unit, otherwise heat from the unit will immediately satisfy the thermostat and turn the unit off.

Wiring Instructions

The valve post connections are found by opening the bottom center grill on the front of the unit. Also, refer to *Figure 8* when making these connections; position the thermostat wire so it extends out the side surround panel towards the thermostat. (At the thermostat, connect the wires to the two connection screws on the back of the thermostat per the instructions received with the thermostat. Take care not to over-tighten the connection screws and not to damage the internal parts of the thermostat. Now attach the wires in their proper location on the firebox.

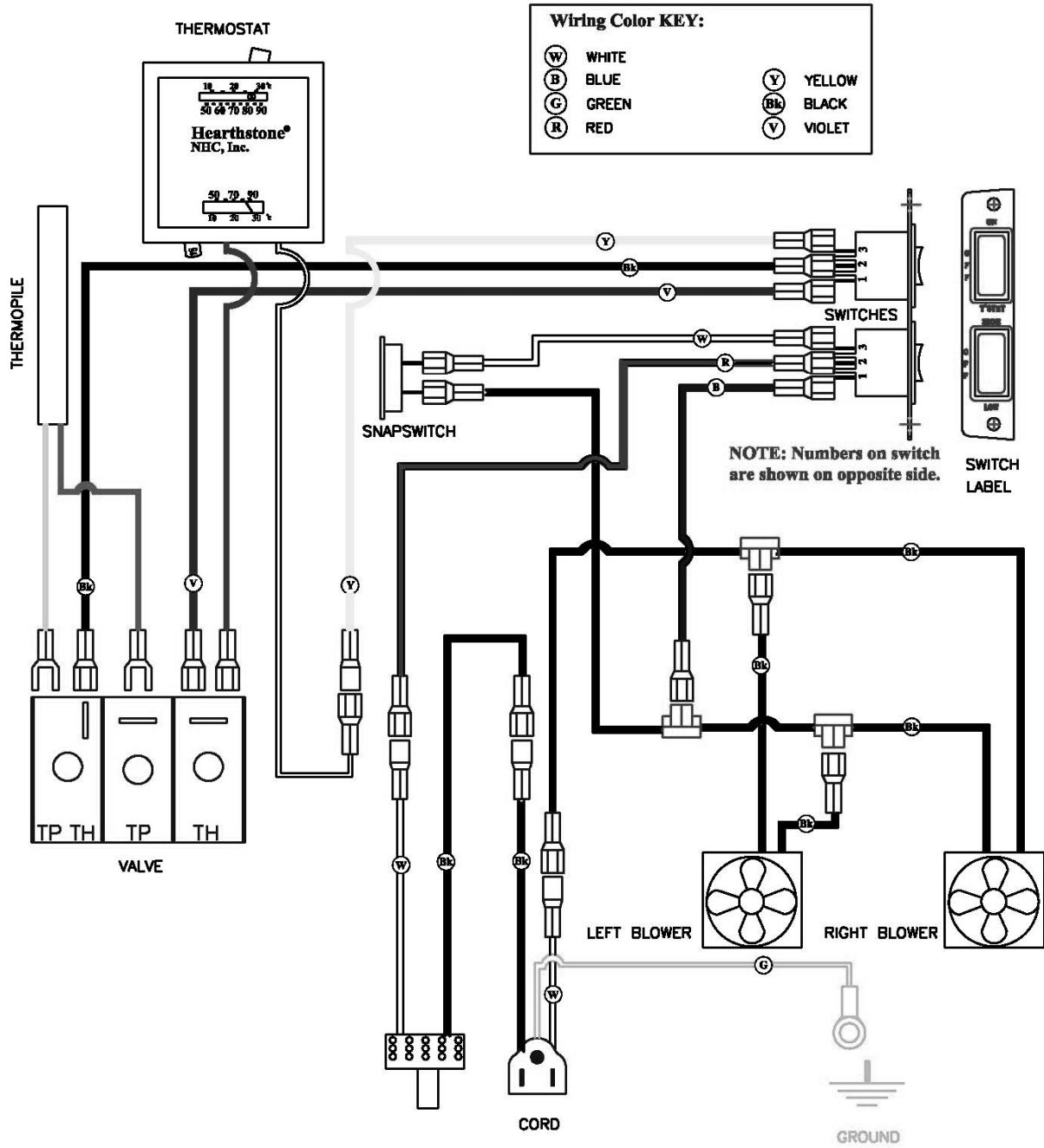

Figure 4: 8890 Wiring Diagram

GAS SUPPLY AND CONNECTIONS

NOTICE: A qualified technician must connect the heater to the gas supply and leak test the unit before it is approved for use. Consult all local codes.

WARNING: THE UNIT MUST BE INSTALLED AND CONNECTED IN ACCORDANCE WITH LOCAL CODES, OR IN THE ABSENCE OF LOCAL CODES, WITH THE MOST CURRENT EDITION OF THE NATIONAL FUEL GAS CODE ANSI Z223.1.

We recommend using new black iron or steel pipe only. Internally tinned copper tubing can be used in some areas when permitted by local codes. Only use pipe of sufficient diameter to allow full gas volume to heater, without undue loss of pressure. Excessive pressure loss will occur if the pipe is too small.

The gas supply line must include a manual shut-off valve and union so the unit can be disconnected for servicing. Also a sediment trap and a 1/8" N.P.T. plugged tapping must be installed upstream of the heater. The sediment trap is installed to prevent moisture and contaminants from passing through the pipe to the heater controls and burners. Failure to install a sediment trap could prevent the heater from operating reliably. The 1/8" N.P.T. plugged tapping is installed for the test gauge connection (immediately upstream of the gas supply connection). Damage to the valve caused by lack of a sediment trap will not be covered by the warranty.

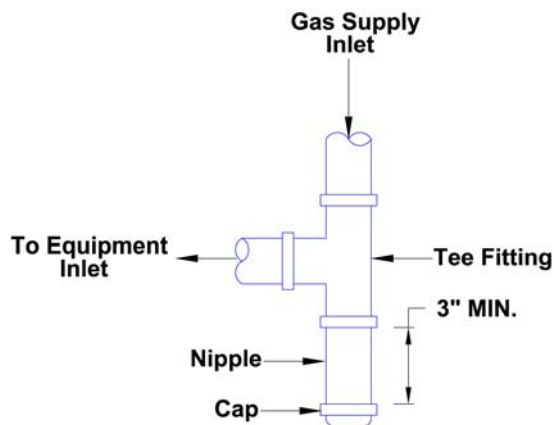

It is mandatory to install a sediment trap on all installations

We have supplied a 36" flexible stainless steel gas line for installation convenience and to avoid undue

mechanical load on the valve. We recommend using the flexible line, but also refer to local code. The gas supply line connection is made to the flexible line in the lower rear right portion of the DVI-Ht. Apply a thread sealant to both male ends on the flexible gas line. Thread one end directly into the valve and the other to a 3/8" connector on the gas line.

CAUTION: CHECK GAS TYPE! THIS UNIT IS SUPPLIED AS NG ONLY. A LP CONVERSION IS ALSO SUPPLIED. A QUALIFIED TECHNICIAN MUST DO THE CONVERSION. THE GAS SUPPLY MUST BE THE SAME AS STATED ON THE HEATER'S RATING PLATE (LOCATED ON THE UNIT). IF THE GAS SUPPLY IS DIFFERENT, DO NOT INSTALL THE HEATER. CONTACT YOUR DEALER FOR THE CORRECT MODEL OR CONVERSION KIT.

GAS PRESSURE ADJUSTMENT: A QUALIFIED TECHNICIAN MUST PERFORM THIS PROCEDURE!

The supply line pressure is tested, to ensure it meets minimum pressure requirements, as listed in the Specifications sections of this manual, for the type of fuel in use (NG or LP). The unit must be isolated from the gas supply piping system by closing its individual manual shutoff valve during any pressure testing of the gas supply piping system at test pressures equal to or less than 1/2 psig. During tests in excess of 1/2 psig. (14" w.c.), the heater must be disconnected from the gas supply system. Test by connecting a manometer to the supply line. Adjust the incoming pressure, if necessary, to meet the required supply line pressure. Once connected to the gas supply, the gas inlet pressure and manifold gas pressure must be tested. The gas inlet tap (6) and manifold pressure tap (7) is located on the control valve (see Figure 8). Connect a manometer to the test points on the gas control valve; refer to #'s 6 & 7 of Figure 8 for locations.

NOTE: For installations from 610-1370 meters (2000-4500 ft.), the orifice sizes (DMS) for natural gas are 44,52 and for propane gas are 56 and 62 . (*Cet appareil est équipé pour des altitudes comprises entre et 2000-4500 pieds (610-1370m) seulement.*) See data plate for additional information. For high altitude installations consult the local gas distributor or the authority having jurisdiction for proper rating methods. If the unit must be adjusted, the information sticker (provided with the high altitude kit) must be filled out completely and mounted to the unit per the instructions provided with the kit.

VALVE DESCRIPTION

- | | | |
|---------------------------------|------------------------------|-----------------------------------|
| ① Gas cock knob | ⑥ Inlet pressure test point | ⑪ Flange securing screw holes |
| ② pressure regulator (LP or NG) | ⑦ Outlet pressure test point | ⑫ Additional valve mounting hole |
| ③ Pilot adjustment | ⑧ Main operator | ⑬ Alternative TC connection point |
| ④ Termocouple connection | ⑨ Pilot outlet | ⑭ Thermoelectric unit |
| ⑤ Mounting for piezo & bracket | ⑩ Main gas outlet | |

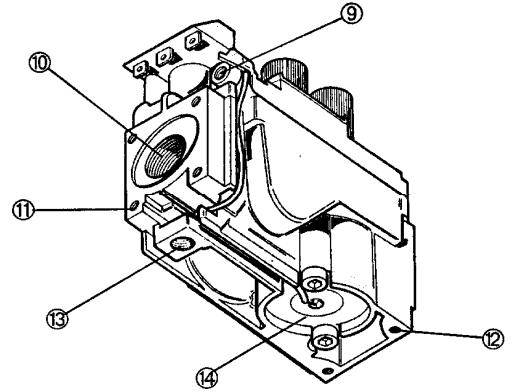
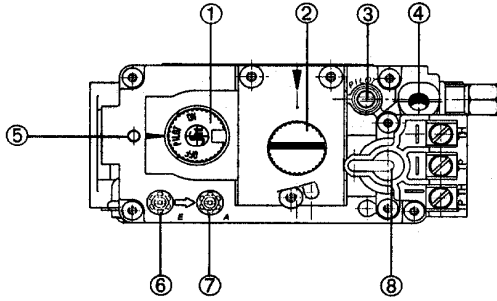

Figure 5

ASSEMBLING AND INSTALLING THE UNIT

Log Placement within the Unit



Figure 9: Log Placement

Fragile! Handle logs with care. Always wear gloves and safety goggles while handling the log set.

- 1) To open the firebox, reach over the firebox, and under the front grill. With a flat screwdriver pry the retaining clips up. There will be four separate clips. Be careful, when you lift the last one, as it will free the glass and frame from the unit. Place the glass and frame in a safe place.
- 2) Install the left and right ember filler pieces. Refer to figure below.

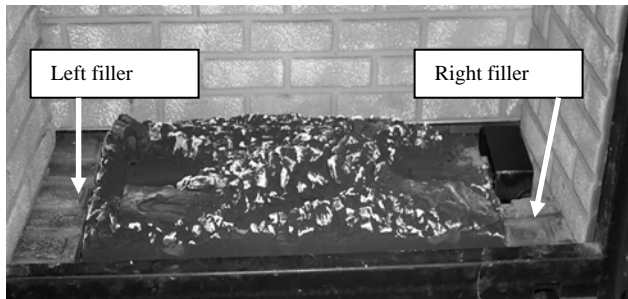

- 3) Spread the charcoal embers over the gaps between the ember bed and the filler pieces. These embers are intended to cover the seam between the two. (These embers will not glow when the unit is turned on) See figure below.

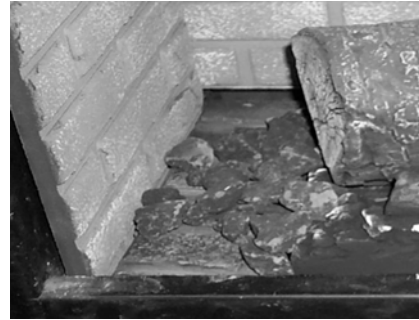

- 4) Install the four main logs as shown in the figure below. Spread the Platinum Bright Embers over the logs and burner.

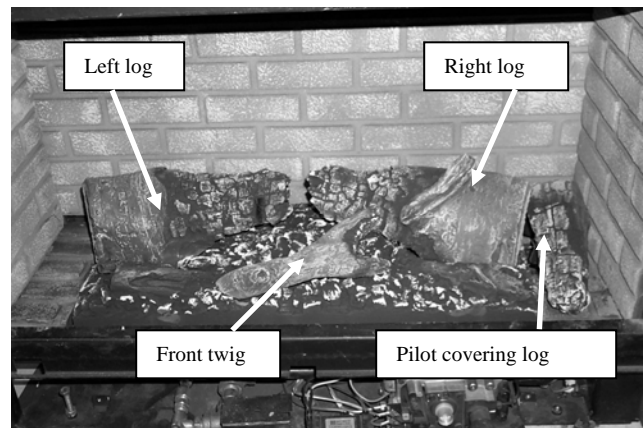

Leave embers off the pilot to allow the pilot flame to ignite the ignition ports on the burner tube.

- 5) Replace the glass and frame.

Log Set Removal

To remove the log set, follow the "Log Placement Within the Unit" instructions in the reverse order on page 16.

Surround and Façade Installation

See instructions included with assemblies.

Installing the Unit

1. Place a level on top of the unit. Leg leveling bolts are located in the front and rear of the base plate. Adjust the rear leveling bolts now as they will not be accessible once the unit is fully inserted into the fireplace.

2. Push the unit as far into the fireplace as you can, leaving just enough room for the fan power cord to exit on the bottom left or right side, between the surround and fireplace.
3. Before replacing the front cast, carefully unwrap and place the log set into the unit. Refer to the Log Placement section of this manual, on page 18 for the precise positioning of the log.

Pull-Out Gas Service Tray

To ease in the installation and service of the DVI-Ht the unit is equipped with a pullout tray under the viewing flame, to ensure proper access to the valve, pilot connections, and igniter battery compartment. To pull out the tray simply unscrew the two 8-32 screws on either sides of the control knobs. Once these are removed, pull the tray by the two tabs the screws were located on. Once the service work is complete, push the tray back to its original position and replace the screws.

A built in gas shut-off valve is installed on the unit directly off of the valve. In the event of a gas leak shut the gas off at this point first, and then follow the instructions on the cover of this manual

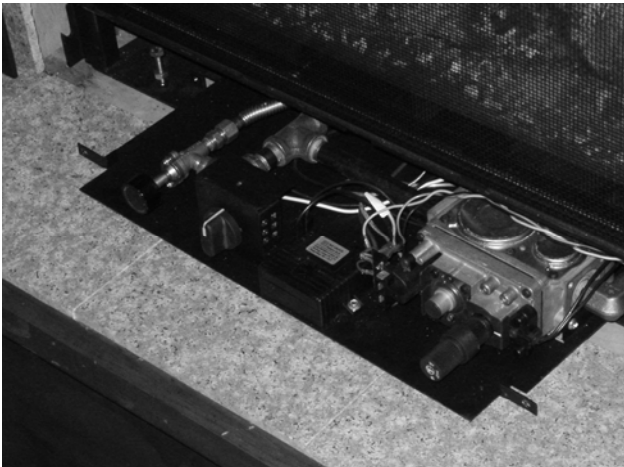

Figure 10: Gas Service Tray (pulled out position)

Installing the Glass and Frame

1. Set the bottom of the glass frame into the two grooves on the bottom of the firebox.
2. Push the top of the glass/frame into the firebox.
3. Pull the 4 retaining clips down, securing the glass into the firebox seal.
4. Attach the front cast to the firebox by setting the two knobs into the receiving holes on the firebox. Center the front and push the top in until it "clicks" shut.

Place a level on the top of the unit. Two leveling leg bolts are located in the front of the base plate. Use a wrench to turn these bolts up or down as necessary to level the unit. Note, leveling bolts are also located in the back of the base, but the insert must be pulled out of the fireplace to gain access to them.

LIGHTING THE UNIT FOR THE FIRST TIME

CAUTION: LIGHTING THE DVI-HT FOR THE FIRST TIME AND ADJUSTMENTS TO THE UNIT SHOULD BE PERFORMED BY QUALIFIED SERVICE PERSONNEL.

Smoke and Fumes Warning

When lit for the first time, the unit will emit some smoke and fumes. This is normal “off-gassing” of the paints and oils used in the manufacturing and assembly of the unit. Open windows to vent the room if necessary. The off-gassing and fumes will usually subside after the first 10 to 20 minutes of operation.

Odors and Impurities

A heater of this type may produce odors during heater operation due to impurities that may exist in the immediate area. Sources of impurities can be cleaning solvents, paint solvents, cigarettes, smoke, pet hair, dust, adhesives, new carpet, and/or textiles. Such odors will dissipate. However, opening a window or otherwise providing additional ventilation to the area can alleviate the condition. If any odor persists, contact your dealer or an authorized service technician.

Pilot Light Warning

The DVI-Ht has an electric spark igniter, which ignites the pilot light by means of a spark at the pilot light assembly. Do not attempt to light the unit with a match or by any means other than the electric spark igniter

Prepare for Lighting

Prepare for the lighting procedure by adjusting the thermostat to its lowest setting or OFF position. If the gas control knob is not in the OFF position, turn the knob fully clockwise to OFF. Locate the variable output control knob and turn it fully counterclockwise to the highest setting.

Initial Adjustments

Once the DVI-Ht has been set in place, connected and assembled as described in the Assembly of the Unit, Electrical Connections, and Gas Supply & Connections sections of this manual, the unit is ready to be lit for the first time. Each unit is tested prior to shipment by the manufacturer, so ignition should take place without failure. However, a number of small adjustments may be necessary to compensate for variations in gas pressure, altitude, and other factors particular to each installation.

Prior to lighting the unit for the first time, wait 5 minutes to allow any residual gas within the unit to dissipate. Smell all around the appliance area for gas. Be sure to smell next to the floor because some gases are heavier than air and will settle on the floor. If you do not smell gas after this five-minute period, proceed with the lighting procedure. If you do smell gas, do not proceed with the lighting procedure. Instead, **immediately refer to the What to Do If You Smell Gas Warning, on the cover of this manual.**

Lighting Instructions

The gas control knobs are located behind the valve door at the bottom of the unit.

1. Set the on/off/T-stat switch or thermostat to the off position.
2. Unplug the blower accessory, if so equipped
3. Push in and turn gas control knob clockwise to “OFF”. *(If not previously lit, the knob should be in this position.)*
4. Wait (5) five minutes to clear out any gas. If you then smell gas, STOP! *Smell all around the appliance area for gas. Be sure to smell next to the floor because some gases (LPG) are heavier than air and will settle on the floor. If you smell gas immediately follow the What To Do If You Smell Gas! warning on the cover of this Manual.* If you do not smell gas, go to the next step.
5. Turn gas control knob counterclockwise to “PILOT”.
 6. Push in control knob all the way and hold in. (You should hear the clicking of the Piezo igniter in the firebox) Verify ignition of the pilot. Continue to hold the control knob in for about 20 seconds after the pilot is lit. Release the knob and it will pop back out. Pilot should remain lit. If the pilot goes out, repeat the operation.
 - If knob does not pop out when released, stop and immediately call a qualified service technician or gas supplier.
 - If the pilot will not stay lit after several tries, turn the gas control knob “OFF” and call a qualified service technician or gas supplier.
7. Turn gas control knob counterclockwise to “ON”.
8. Select “ON” or “T-STAT” position on the on/off/t-stat switch.
9. Plug in the blower.
10. Set thermostat to “ON” and set the desired temperature setting.

Normally, if the "T-STAT" position was selected, the main burner is cycled on and off by the Thermostat or the "on", "off" switch located on the bottom of the Thermostat body.

To Turn Off The Gas To The Appliance

Turn the gas control knob clockwise to "OFF" position. If shutting the unit off for the non-heating season, this will improve the overall efficiency of the unit as the heat from the pilot is wasted in the summer. When putting the unit back into service follow the lighting instructions described on the previous page.

Once the pilot has been lit, and the gas control knob has been turned to the "ON" position, the main burners are lit by setting the "ON/OFF/THERMOSTAT" switch to "ON" or to "THERMOSTAT". If using the optional thermostat, turn the thermostat to "ON" and set it to a higher position so that it "calls" for heat (i.e. turns the unit on). The main burners should light immediately. Note that the thermostat controls the on/off cycling of the main burners, but the pilot remains lit regardless of the thermostat setting. To turn the

pilot off, turn the gas control knob fully clockwise to the "Off" position.

WARNING: THE CONTROL HAS AN INTERLOCK DEVICE. AFTER SHUTTING OFF ALL GAS FLOW, THE PILOT BURNER CANNOT BE RELIT UNTIL THE THERMOCOUPLE HAS COOLED, ALLOWING THE ELECTROMAGNET TO BE RELEASED (APRX. 60 SEC). THE GAS CONTROL KNOB IS DESIGNED TO BE OPERATED BY HAND. NEVER USE ANY TOOLS DURING THIS OPERATION. IF THE KNOB WILL NOT PUSH IN OR TURN BY HAND, DON'T TRY TO REPAIR IT, CALL A QUALIFIED SERVICE TECHNICIAN. DAMAGED KNOBS MAY RESULT IN FIRE, EXPLOSION, OR SERIOUS INJURY.

Turning Off the Unit

1. Set the "ON/OFF/THERMOSTAT" switch to the "OFF" position, or turn the thermostat to the "OFF" position.
2. If shutting the unit off for the non-heating season, turn the gas control knob fully clockwise to the "OFF" position. Do not force the knob to turn.

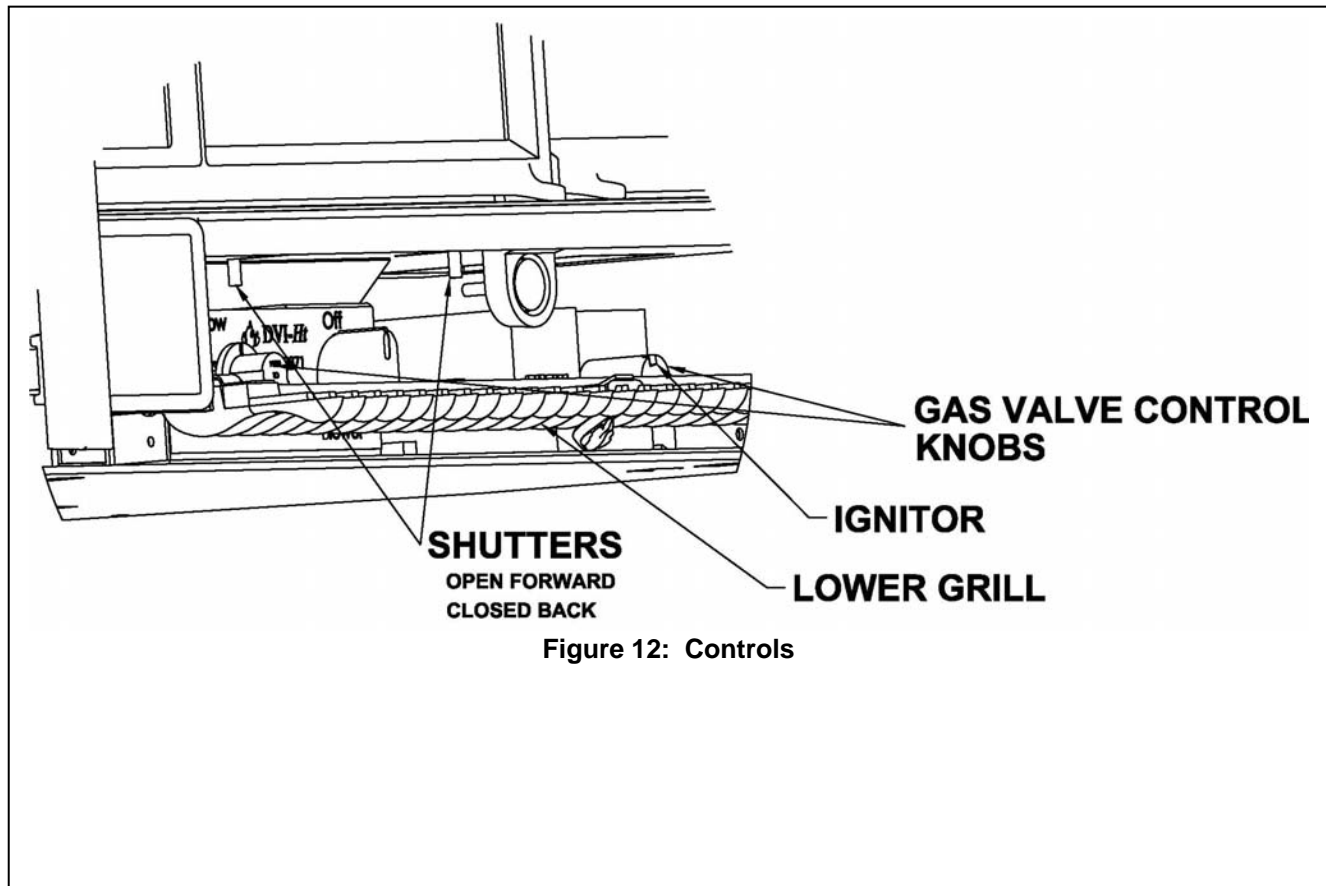

Figure 12: Controls

PILOT AND BURNER FLAMES

Variable Output Control

The gas control valve is equipped with a variable output control. This control varies the rate of heat produced by the unit by varying the gas pressure to the main burner tube. The length of the burn cycle is affected by a combination of heat output and the thermostat setting. If your stove turns on and off too often, try, first, reducing the burn cycle by turning the HI/LOW knob, on the control valve to a lower setting. Using the variable output control, the heat output of the unit can be reduced for mild fall and spring months, or maximized for the colder winter months. This adjustment is made, by the homeowner, as necessary by turning the variable output control knob to "HI", "LO", or any setting in between.

Ht (High Turndown)

The DVI is equipped with a dual valve system. This allows for the dramatic turndown that most other gas systems do not feature. Turn the secondary valve off, and the rear flames go out leaving the front flames on for a more relaxed ambience simmer. Turn the rear flames back on to enjoy the high flames for more heat. This *Ht* system is technologically designed to cover all aspects of heating pleasure.

Air Shutter

The air shutter is adjustable while the stove is burning. The two air shutters on the ember burner are adjustable. The right one (while facing the front of the stove) is for the low burn portion of the ember burner and the left one (while facing the front of the stove) is for the high burn portion of the ember burner. The adjusters are located underneath the front of the unit, and operated by using a 3/8" wrench to loosen the bolt. Sliding the control levers forward or backward will open or close the shutters. This nut is gets hot and should not be touched. Use only metal tools for this adjustment. Tighten the nut after making adjustment. The air shutter is factory set and only a qualified gas technician should make adjustments.

Pilot Adjustment

The pilot light is preset by the manufacturer and should not need adjustment. Ensure the pilot flame is large enough to engulf the thermopile and the thermocouple, but not so large as to create excessive noise or consume excessive gas. However, adjustment is possible by means of the pilot light adjustment screw located on the gas control valve. Open the valve door to access the pilot adjustment screw. Refer to # 3 of Figure 8, on page 15, to determine the location of the pilot adjustment screw.

Note that the pilot flame must engulf the thermopile so the thermopile can generate sufficient voltage (325 to 750mv) to power the millivolt gas control valve. The flame on the pilot should look like Figure 13. Controlling the DVI -Ht by the wall-mounted thermostat may become erratic, nonexistent, or the unit may go out, if the pilot flame is too small or misdirected away from the thermopile.

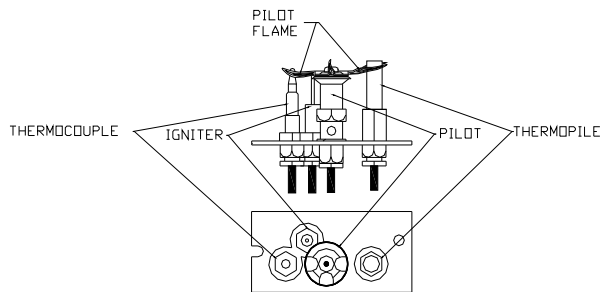

Figure 13: Top Convertible Pilot

Burner Flame Appearance

Once the unit is lit, observe the flame pattern and adjust as necessary. Perform a periodic visual check of the burner flame. To determine if the burner flame needs adjustment, view the flame pattern with the variable output control knob at its highest setting (turned fully counter-clockwise). Allow the unit to operate for 10 minutes enabling the entire unit to reach temperature and for the flame pattern to stabilize. The flame pattern should be similar to the one shown in Figure 14. There are several guidelines to aid in determining if the flame pattern is correct:

- 1) The flame should not be dirty, smoky, sooty, or lick the top of the stove.
- 2) The flame should not rise off of the burner tube, called "lifting". Flames should not impinge heavily on log set; they should "fit" through the pre-formed spaces designed in the log set.



Figure 14: Flame Pattern

MAINTENANCE AND CARE

The DVI -Ht requires minimal routine maintenance and care. The unit should always be cool and off when being cleaned.

🔥 WARNING: DO NOT SUBSTITUTE MATERIALS FOR REPLACEMENT PARTS, OR FOR INFORMATION ABOUT PARTS OR SERVICE, CONTACT YOUR LOCAL HEARTHSTONE DEALER.

NOTE: Label all wires prior to disconnecting when servicing controls. Wiring errors can cause improper and dangerous operation. Verify proper operation after servicing.

Replacing the Glass

1. Remove the cast front by lifting and pulling away from the unit. Carefully set aside.
2. Pull the 4 retaining clips up.
3. Pull the top of the glass and the frame out and up.
4. Install the new frame per the instructions on page 19

Cleaning

🔥 WARNING: DO NOT CLEAN THE UNIT WHEN HOT! THE UNIT SHOULD RECEIVE REGULAR CLEANING ON, UNDER, AND AROUND THE STOVE TO PREVENT THE BUILDUP OF DUST AND LINT. THE EXTERIOR SURFACES OF THE UNIT CAN BE CLEANED USING SOAP, WATER, AND A SOFT CLOTH. DO NOT USE ABRASIVE OR CHEMICAL CLEANERS AND TAKE CARE NOT TO SCRATCH THE GLASS OR ENAMEL FINISH (IF SO EQUIPPED) WHEN CLEANING THE UNIT.

Firebox

The firebox should receive periodic cleaning to prevent the accumulation of dust, lint, and other debris. To clean the firebox, turn the valve to the "OFF" position, and turn off the gas at the gas control valve. When the unit is cool, remove the front and carefully remove the decorative TEK fiber log set (after it too, has cooled), taking care not to damage the logs or chip the enamel cast iron. Clean the firebox, burner tube, pilot assembly, and carefully vacuum the entire surface of the log set. Take care to thoroughly vacuum the ports (holes) along the top of the burner tubes and the pilot assembly.

Pilot & Burner Flames

The ember burner and logs are delicate components for this model. They are easily damaged. Take care

when cleaning the unit. Check and clean any burner ports, which were not burning properly or at all. Clean burner ports using a soft brush or vacuum cleaner. If the pilot flame height needs adjustment it should be adjusted by a qualified service technician as described in the Initial Adjustments section of this manual.

Complete the cleaning procedure by carefully placing the log set within the firebox as described in the Log Set Information section of this manual. Close and fasten the front. Turn on the gas, light the unit and check for proper operation. Flame patterns should look like the one pictured in *Figure 14*. Regularly check to insure the area around the DVI -Ht is kept free and clear from combustible materials, gasoline, and other flammable vapors and liquids. Check that the flow of combustion and ventilation air is not obstructed. **Once a year the unit should be inspected by a qualified service technician to ensure that it is clean, free of obstruction, safe, and in the venting is in good working order. If service or maintenance is required, it should be performed by a qualified service technician.**

Cleaning the Glass

If operating on propane, it may be necessary to clean the inside of the glass after break-in and occasionally. Do not use abrasive cleaners, steel wool, or a razor blade. Scratching the glass will weaken the integrity. Your dealer will usually stock a gas fireplace glass cleaner or a window cleaning fluid will work adequately. **Do not clean when hot!!**

🔥 WARNING: DO NOT OPERATE THIS APPLIANCE WITH THE GLASS PANEL REMOVED, CRACKED OR BROKEN. CONTACT YOUR AUTHORIZED DEALER FOR REPLACEMENT GLASS.

For replacement parts, or for information about parts or service, contact your authorized Hearthstone retailer. For the name of the authorized retailer nearest to you visit our website at www.hearthstonestoves.com, or e-mail us at inquiry@hearthstonestoves.com.

Hearthstone
317 Stafford Ave.
Morrisville, Vermont 05661

PARTS LIST

<u>Part No.</u>	<u>Description</u>
2810-400	GRILLE: TOP, MATTE, KIL
2810-824	HEAT EXCHANGER:
2810-825	HEAT EXCHANGER: BASE
2810-910	GRILLE: BOTTOM
2810-920	HANDLE: FLAME
2810-930	FRAME: CENTER
2810-940	DOOR: LEFT
2810-950	DOOR: RIGHT
3030-021	GLASS: 25-29/32"x13-13/16"x5mm, DVI
3120-890	FILLER: BURNER LOG, LEFT
3120-891	FILLER: BURNER LOG, RIGHT
3120-892	BRICK PANEL:, SIDE
3120-893	BRICK PANEL:, REAR
3170-150	PLATINUM BRIGHT EMBERS
3300-570	LABEL: SAFETY/RATING&LIGHTING INSTRUCTIONS, DVI
3300-649	LABEL: FUEL CONVERSION
5800-085	LIMITER: HEAT EXCHANGER, RIGHT, WIN/DVI 32
5800-090	LIMITER: HEAT EXCHANGER, LEFT, WIN/DVI 32
5870-055	PLATE: RESTRICTOR, WIN/DVI 32
5870-090	FRAME: GLASS RETAINER, DVI 32
5870-092	CLIP: FRAME, GLASS RETAINER, CHA/STO/DVI
5890-010	FIREBOX, DVI
5890-020	VALVE BRACKET
5890-025	PILOT SHIELD
5890-030	INTAKE PLENUM
5890-040	TEK BOARD SUPPORT
5890-046	AIR SHUTTER, LEFT
5890-047	AIR SHUTTER, RIGHT
5890-050	EXHAUST
5890-055	BLOWER PLATE
5890-060	BLOWER SHROUD
5890-075	AIR DIVERTER
5890-080	BAFFLE SS
5890-085	TOP AIR SHROUD
7211-215	TEK EMBER BURNER
7211-237	TUBE: INLET BURNER
7211-316	VALVE: GAS HIGH TURNDOWN ELECTRO HEAT
7211-317	REGULATOR: VALVE, LP, SIT, CONVERSION
7211-318	VALVE: UNREGULATED SIT MAIN BURNER
7211-506	LOG: LEFT, REAR
7211-507	LOG: RIGHT REAR

7211-508	LOG: CENTER TWIG
7211-509	LOG: PILOT FILLER
7211-517	Charcoal embers 4oz.
Part No.	Description PARTS LIST cont.
98-56900 (NG)FUEL CONVERSION	
3300-651	LABEL: BAG,NG CONVERSION KIT,WIN/DVI 32
7200-743	ORIFICE: BURNER HOOD,#43 SPUD
7200-752	ORIFICE: BURNER HOOD,#52 SPUD
7211-163	ORIFICE: PILOT,NG,.62mm,CONVERT TOP,SIT
7211-319	REGULATOR:VALVE,NG,SIT, CONVERSION
98-56902	
(LP)FUEL CONVERSION	
3300-648	LABEL: BAG,LP CONVERSION KIT,WIN/DVI 32
7200-755	ORIFICE: BURNER HOOD,LP,#55 SPUD
7200-762	ORIFICE: BURNER HOOD,#62 SPUD
7211-136	ORIFICE: PILOT,LP,.35mm,CONVERT TOP,SIT
7211-317	REGULATOR:VALVE,LP,SIT, CONVERSION
HIGH ALTITUDE KIT	
7200-362	ORIFICE: BURNER HOOD,LP,#62 SPUD (LOW)
7200-344	ORIFICE: BURNER HOOD,NG,#44 SPUD (HIGH)
7200-352	ORIFICE: BURNER HOOD,NG,#52 SPUD (LOW)

TROUBLESHOOTING

Symptom	Possible Cause	Corrective Action
1. Pilot will not light.	A. Insufficient gas pressure, air in the pilot line, or dirty or kinked gas line.	A. Using the piezo igniter, try to light the pilot. If it will not light, check the inlet gas pressure.
	B. Pilot orifice plugged.	B. Clean or replace the pilot assembly.
	C. Defective or misaligned electrode at pilot.	C. If a match lights a pilot, check the electrode gap and location. Should be a 1/8" gap in the flame area.
	D. Defective igniter.	D. Check for a good connection between igniter and electrode. Check wire insulation. If properly connected and no spark, check/replace battery. With new battery and still no spark replace igniter.
	E. After sitting for "off" season (summer), pilot assembly may be dirty.	E. Clean or replace the pilot assembly.
2. Pilot will not stay lit after carefully following lighting instructions.	A. Low or too high gas pressure	A. Check for proper inlet pressure for the gas being used.
	B. Faulty connections.	B. Measure voltage between valve body and solder connection on the rear of the valve (where the blue wire connects). It should be no less than 7 mV.
	C. Defective thermocouple.	C1. Ensure that the thermocouple connection at the gas valve is tight. C2. Check thermocouple output using milli-volt meter. Disconnect from valve and read voltage across wire ends. If the reading is less than 15 mV, replace the pilot assembly. C3. If burning NG, check pilot flame to see that it is impinging on the top of the thermocouple. Clean or replace pilot for maximum flame impingement.
	D. Pilot dirty or plugged.	D. Clean or replace the pilot assembly.

Symptom	Possible Cause	Corrective Action
3. Pilot burning, no gas to main burner, and valve knob in the "ON" position, thermostat and/or on/off/t'stat switch in the "ON" position.	A. Thermostat switch or wires defective.	A. Check thermostat/wiring for proper connections. Place jumper wire across terminals at thermostat. If burner comes on, replace defective thermostat. If not OK, place jumper across thermostat wires at gas valve. If burner comes on, tighten connections, or replace faulty wires.
	B. Thermopile may not be generating sufficient voltage.	B. Check thermopile output, using a milli-volt meter. If the optional on/off kit has not been installed, take the readings across generator terminals of the gas valve. (TPTH and TP). With the on/off kit, take the readings across TH and Terminal block (which corresponds to #3 on the switch). Milli-volt reading should be greater than 325 mV. If not, replace the pilot assembly. If the meter reading is OK, but the burner does not come on, replace the gas valve.
	C. Plugged burner orifice.	C. Remove and check burner orifice, clean or replace. Note: do not use any metal cleaning device, as this may damage the orifice.
4. Pilot and burner come on, but go out after some warm-up.	A. Inconsistent, of insufficient flame on thermopile.	A. Adjust pilot flame size and assure that the flame is aimed directly at the thermopile.
	B. Insufficient gas pressure.	B. Check line pressure to ensure that the correct inlet pressure is present for the type of gas being used. If propane pressure is inconsistent, check for water condensation at the regulator.
5. Frequent pilot outage problem.	A. Pilot flame may be too low or blowing, (high), causing the pilot safety to drop out.	A. Clean and/or adjust the pilot flame for maximum impingement on the thermopile and thermocouple.
6. Glass fogs	A. A normal result of gas combustion.	A. After the heater has warmed up, the glass should clear.
7. Blue Flames	A. A normal result during the first 20 minutes.	A. Flames should begin to turn more yellowish after 20 minutes of burning. B. If the blue color stays; adjust the air shutter for a proper burn.

Symptom	Possible Cause	Corrective Action
<p>8. Floating flames, lazy ill-defined, quiet flames, which roll around, sometimes completely off of the port, sometimes with overly, yellow tips. Possible sooting. Usually accompanied by the odor of aldehydes.</p>	<p>A. Potentially dangerous incomplete combustion due to incorrect air to fuel ratio (lack of combustion air or excessive fuel delivery i.e. excessive gas pressure, overrating of appliance). B. Incorrect air intake/exhaust flow system. Causes may be: B1. Blocked burner. B2. Blocked primary air B3. Blocked secondary air inlets</p>	<p>A. Check the appliance input rate and reduce if necessary. The air intake/exhaust flow system may be too restrictive or blocked (the rate at which the exhaust leaves [draft] determines the rate at which the combustion air is delivered). Poor draft results in insufficient air delivery or a restricted exhaust. Correct air intake/exhaust flow system. B1. Clear ports. B2. Clear obstructions. B3. Clear obstructions. C. If gas pressures are correct and the flames stay the same, adjust the air shutter for a proper burn.</p>
<p>9. Burner flashback. Air-gas mixture ignites inside the burner near the orifice, usually creating a roaring noise like a blowtorch. The problem is an imbalance of gas flow velocity and burning speed pattern.</p>	<p>A. Excessive. B. Burner input underrated. C. Valve leak if flashback occurs with burner valve in off position. D. Improper gas pipe size.</p>	<p>A. Adjust the air shutter for a proper burn. B. Check input rate. Check input pressure using a manometer. Confirm correct gas pressure at house meter or tank (call gas company). Confirm burner orifice size. C. Replace valve. If above corrections do not eliminate flashback, replace burner. D. Correct plumbing.</p>
<p>10. Delayed ignition (makes a sudden "whoosh" noise as the burner lights). This is a buildup of gas prior to ignition. This is more prevalent with propane (LP) fuel.</p>	<p>A. Incorrect air-to-fuel ratio. A1. Primary air incorrect. A2. Burner ports plugged. B. Improper log placement.</p>	<p>A1. Adjust the air shutter for a proper burn. A2. Open ports to allow for proper travel of flames. B. Reposition logs to eliminate interference with flame travel.</p>

SAFETY LABEL



MODEL # 8890-
SERIAL #



MODEL NAME: DVI-Ht DIRECT VENT GAS FIRED INSERT
LISTED: GAS FIRED DIRECT VENT FIREPLACE HEATER
TESTED TO: ANSI Z21.88-05 CSA 2.33-M05, CAN/CGA-2.17-M91

CERTIFIED FOR CANADA/HOMOLOGUE POUR LE CANADA
ALSO FOR MOBILE HOME INSTALLATION

CAUTION: DO NOT OPERATE WITH GLASS REMOVED, CRACKED, OR BROKEN
Replacement on the panel should be done by a licensed or qualified service person.
CAUTIONNER: N'opère l'appareil avec le verre enlevé, craqué ou cassé. Le remplacement du panneau devrait être fait par une personne de service qualifié ou autorisé.

This appliance must be installed in accordance with the local codes, if any; if not, follow the National Fuel Gas Code, ANSI Z223.1 or Canadian Installation Codes, CAN/CGA B149. (Installer l'appareil selon les codes ou règlements locaux, ou, en l'absence de tels règlements, selon les Codes d'installation CAN/CGA-B149.)

FUEL TYPE:	■ NG	■ LP
INPUT RATING (Btu/hr) 0-2000 ft	33,000	33,000
INPUT RATING (Btu/hr) 2000-4500 ft	32,800	32,000
ORIFICE SIZE (DMS) 0-2000 ft	43, 52	55, 62
ORIFICE SIZE (DMS) 2000-4500 ft	44, 52	56, 62
MANIFOLD PRESSURE - LO (in. W.c./kpa)	1.2/0.3	3.3/0.8
MANIFOLD PRESSURE - HI (in. W.c./kpa)	3.5/0.87	10.0/2.48
MINIMUM INLET PRESSURE (in.w.c./kpa)	5.0/1.24	11.0/2.88
MINIMUM INPUT RATING (btu/hr) 0/2000 ft	13,000	12,000
MAXIMUM OUTPUT (btu/hr) 0-2000 ft	26,900	26,200

WARNING: Improper installation, adjustment, alteration, service or maintenance can cause injury or property damage. Refer to the owner's information manual provided with this appliance. For assistance or additional information consult a qualified installer, service agency or the gas supplier. (L'AVERTISSEMENT: L'installation inconvenante, ajustement, modification, service ou entretien peut causer le dommages de propriété ou blessure. Référez au manuel d'information de propriétaire fourni cet appareil. Pour l'assistance ou information supplémentaire consultez un qualifié installateur, agence de service ou le fournisseur de gaz.)

MINIMUM CLEARANCES TO COMBUSTIBLES

TOP AIR OPENING TO MANTLE	15" / 381mm
FLOOR PROTECTION FROM FRONT OF UNIT	14" / 356 mm
UNIT TO SIDE WALLS	8" / 204 mm

ELECTRICAL RATING:
115 VOLTS @ 60Hz, LESS THAN 2.0A

Several Optional kits are available through HearthStone or your local HearthStone dealer. A spark screen (kit# 98-69700) and two different remote controls (kit #90-56912 & kit #90-56914) are optional as well.

This appliance is only for use with the type of gas indicated on this rating plate and may be installed in an aftermarket, permanently located, manufactured (mobile) home where not prohibited by local codes. See owner's manual for details. This appliance is not convertible for use with other gases, unless a certified kit is used. If the vent air intake system is disassembled for any reason, reinstall per the instructions provided with the initial instructions. This vented gas fireplace heater is not for use with air filters. This appliance must be properly connected to a venting system in accordance with the manufacturer's installation instructions.

VENTED GAS FIREPLACE HEATER - NOT FOR USE WITH SOLID FUEL.

MANUFACTURED BY: HearthStone, MORRISVILLE, VERMONT 05661



Date of Manufacture

2009 2010 2011 Jan Feb Mar Apr May Jun Jul Aug Sep Oct Nov Dec



DO NOT REMOVE OR COVER THIS LABEL

MADE IN USA

3300-570

WARRANTY REGISTRATION

The Original Purchaser may send in a completed and signed Warranty Registration Form, which is enclosed in the Stove warranty packet, to the following address:

**Hearthstone Quality Home Heating Products, Inc.
Warranty Department
317 Stafford Avenue
Morrisville, VT 05661**

**NOTE: SENDING IN THE SIGNED WARRANTY REGISTRATION FORM IS NOT A
CONDITION OF WARRANTY COVERAGE OR HEARTHSTONE'S PERFORMANCE.**